

Ruris R450e battery, Ruris R405e fast charger





content

1. Introduction	4
2. Safety instructions	5
2.1 Safety and precautions	7
2.3 Battery storage	9
3. General presentation	11
4. Technical data	12
5. Battery use	13
5.1 Checking the battery capacity	13
5.2 Dismantling batteries and preparation for recycling	13
6. Charger information	14
6.1 Assembly	16
6.2 Operation of the loader	16
6.3 Charging the battery	17
6.4 Charging a hot battery	17
6.5 Charging a cold battery	17
6.6 LED functions	18

1. INTRODUCTION

Dear Client!

Thank you for your decision to purchase a RURIS product and for your trust in our company! RURIS has been on the market since 1993 and during all this time it has become a strong brand, which has built its reputation by keeping promises, but also by continuous investments aimed at helping customers with reliable, efficient and quality solutions. We are confident that you will appreciate our product and enjoy its performance for a long time. RURIS does not offer its customers only machines, but complete solutions. An important element in the relationship with the customer is advice both before and after the sale, as RURIS customers have at their disposal a whole network of partner stores and service points.

To enjoy the purchased product, please read the user manual carefully. By following the instructions, you will be guaranteed a long use.

The RURIS company is continuously working on the development of its products and therefore reserves the right to modify, among other things, their form, appearance and performance, without having the obligation to communicate this in advance.

Thank you once again for choosing RURIS products!





Customer information and support:

Telephone: **0351.820.105**



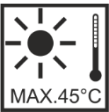

e-mail: info@ruris.ro

2. SAFETY INSTRUCTIONS

Labels on the battery

	<p>Read the manual.</p>
	<p>Do not expose to water and rain .</p>
	<p>CE mark</p>
	<p>Danger of explosion! Never dispose of batteries in fire.</p>
 <p>Li-Ion</p>	<p>Recycle the battery</p>
 <p>MAX.45°C</p>	<p>Do not expose the battery to temperatures above 45 °C</p>

Labels on charger

	<p>Read the manual.</p>
	<p>Use the charger indoors. Do not expose to rain and moisture.</p>
	<p>CE mark</p>
	<p>Double insulation</p>



When charging the battery, the charger and the battery must be left throughout the charging period in a room where there are no products that could be combustible, so in the event of a short circuit or a malfunction of the charger or battery, they are protected and cannot endanger no one. For safety, the room must be constructed of non-combustible materials, such as concrete walls and floors.

It is forbidden to store the battery in places that are not specially arranged. The storage must be safe, without the danger of the stored objects falling and short-circuiting the battery.



It is forbidden to store on top of or near other batteries or objects that could come into contact with the Ruris battery and damage it or even short-circuit it.

It is forbidden to store metallic objects or any other object that has electrical conductivity near the battery or at a distance of less than 50 cm.

It is forbidden to charge the battery without being supervised during the entire charging period by the user.

It is forbidden to store the equipment with a used or damaged battery. If you notice damage to the battery case, the battery must be isolated in an area that cannot endanger the room or the battery and must be handed over immediately to the seller where it was purchased.

Start-up and use are done only after observing the safety conditions specified in the user manual.

Battery storage is done only after the battery is completely discharged and cannot be started

2.1 SAFETY AND PRECAUTIONS

It is important that you read and understand this manual. The information it contains is for YOUR SAFETY. and to PROBLEM PREVENTION. The symbols below are used to help you recognize this information.



DANGER: Indicates an imminently hazardous situation which, if not avoided, will result in death or serious injury.



WARNING: Indicates a potentially hazardous situation which, if not avoided, could result in death or serious injury.



CAUTION: Indicates a potentially hazardous situation which, if not avoided, may result in minor or moderate injury.

CAREFUL

This product may expose you to chemicals including styrene and bisphenol-A,

Some images may vary depending on the model displayed.

DANGER: This manual contains important instructions for using this product. For your safety and that of others, be sure to read this manual carefully before using the

battery/charger. Failure to properly follow all instructions and precautions can result in serious injury to yourself and others.

For the proper use, maintenance and storage of this battery, it is important that you read and understand the following instructions:

- DO NOT test the charger with conductive materials.
- If the battery case is cracked or damaged, do not insert it into the charger. Replace it with a new battery.
- DO NOT charge RURIS batteries with any other type of charger.
- DO NOT spill liquids on the battery or charger.
- DO NOT attempt to use the charger for any purpose other than that described in this manual.
- DO NOT attempt to short any battery terminal.
- DO NOT charge the battery in rain or wet conditions. Do not immerse the tool, battery or charger in water or other liquid.

WARNING:

- DO NOT allow the battery or charger to overheat. If they are warm, let them cool.
- Only recharge at room temperature.
- DO NOT cover the ventilation slots on the top of the charger. Do not place the charger on a soft surface, e.g. blanket, pillow. Keep the charger's ventilation slots clear.
- DO NOT insert small metal objects or materials such as steel shavings, aluminum foil or other foreign particles into the charger's ventilation holes.
- Disconnect the charger from the power source and remove the battery from it before cleaning them. Do not put them in water or other liquids.
- DO NOT place the battery in the sun or in a hot environment. Store at room temperature.



- Store the charger and battery in a cool, dry place.
- Battery cells may develop a small loss of fluid under extreme conditions of use or temperature. If the outer seal is broken and the liquid gets on the skin:
 - Use soap and water to wash off immediately. Neutralize with lemon juice, vinegar or other mild acid.
 - If leakage gets into the eyes, follow the instructions above and seek medical attention.
 - Do not use a wet cloth or detergent to clean the battery or charger.
 - Always remove the battery before cleaning, inspecting or performing any maintenance on the tool.
 - DO NOT disassemble the battery.
 - Keep the battery away from children.
 - DO NOT expose the battery to water.
 - The battery should be stored in a cool and dry place.
 - Do not store the battery in a place with high temperature, near fire sources or heaters
 - DO NOT reverse the positive terminal with the negative terminal of the battery.
 - DO NOT connect the positive terminal and negative terminal of the battery together using metal objects.
 - DO NOT hit or step on the battery.
 - DO NOT puncture the battery with nails or other sharp objects.
 - Stop using the battery immediately if, while using the battery, it emits an unusual smell, feels hot, changes color, changes shape, or appears abnormal in any other way.

2.3 BATTERY STORAGE

The battery benefits from the "**α UP-Innovation RURIS**" function . This function helps the battery when it reaches the critical discharge threshold. Ruris came up with an

innovation in the system of cells inside the battery, through which the battery can be recharged after a long period of time in which it has been discharged. Thus, RURIS users can enjoy the reliability and innovation of RURIS.

After storage, charging is recommended at an interval of 6 months - 1 year

Instructions for storage:

- Battery storage is done only after the battery is completely discharged and cannot be started
- After storage, charging is recommended at an interval of 6 months - 1 year
- Do not store the battery in sunlight, in an excessively hot place or near an oven. Battery life will be shortened.

3. GENERAL PRESENTATION

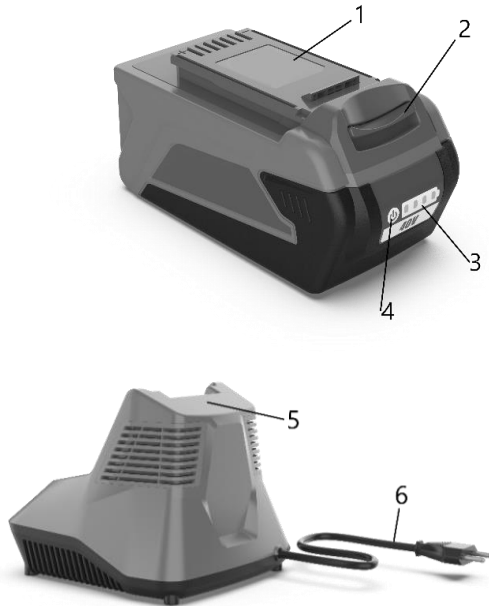

- 1- Battery
- 2- Battery release button
- 3- Charging LEDs
- 4- Button for checking the state of charge of the battery
- 5- Battery charger
- 6- Power cord with plug

The images are informative, the supplier reserves the right to make structural and functional changes to the machine presented in this manual.

4 . TECHNICAL DATA

Model	Ruris R450e battery
tension	40 V
Amperage	5 Ah
Operating Temperature	0~45 °C
Total power	Pw 200Wh
Weight	1.3 kg

Model	Ruris R405e fast charger
Input voltage	200-240V
Frequency	50-60 HZ
Operating Temperature	0~45 °C
Input power	250W
Output voltage	40V
Output current	5.1 A
Weight	0.85 kg

5. BATTERY USAGE

5.1 CHECKING THE BATTERY CAPACITY

Press the power level check button below. The lights will turn on depending on the battery charge level. See the chart below:

Indicator de putere

**Buton
indicator**

LOW
BATTERY

FULL
BATTERY

Lights	Capacity
4 Lights green	Maximum capacity
3 Lights green	70% of capacity
2 Lights green	45% of capacity
1 The light green	10% of capacity, requires loading in the soon
Free lights	Below 10% of capacity, requires loading immediate

5.2 DISASSEMBLY OF BATTERIES AND PREPARATION FOR RECYCLING

Please recycle or dispose of batteries properly. This product contains lithium-ion batteries. Local laws prohibit the disposal of lithium-ion batteries in household waste.

WARNING: After removing the battery, cover the battery terminals with strong adhesive tape. Do not attempt to destroy, disassemble the battery or remove any of its components. Lithium-ion batteries must be recycled or disposed of properly. Also, never touch both terminals with metal objects and/or body parts, as a short circuit may result.



Do not dispose of electrical equipment, industrial electronics and components in household waste! Information on WEEE. Considering the provisions of GEO 195/2005 - regarding environmental protection and GEO 5/2015. Consumers will consider the following indications for handing over electrical waste, specified below:

- Consumers have the obligation not to dispose of waste electrical and electronic equipment (WEEE) as unsorted municipal waste and to collect this WEEE separately.
- The collection of these named wastes (WEEE) will be carried out through the Public Collection Service within each county and through collection centers organized by economic operators authorized for the collection of WEEE. Information provided by the Environmental Fund Administration www.afm.ro or the journal of the European Union.
- Consumers can hand in WEEE free of charge at the previously specified collection points

6. CHARGER INFORMATION

WARNING: READ AND UNDERSTAND THE FOLLOWING INSTRUCTIONS

- Before using the charger, read all instructions and warning labels in this manual about the charger, the battery, and the product that uses the battery.

WARNING: Only charge lithium-ion rechargeable batteries. Other types of batteries may rupture, causing personal injury or damage.

- Do not use the charger outdoors or expose it to moisture. Moisture will increase the risk of electric shock.



- Never use the cable to carry the charger. Do not pull on the charger cable, grab the plug when unplugging. If the cable or charger is damaged, replace the charger or contact an authorized RURIS service.
- Make sure that the location of the cable is done so that it is not stepped on, does not come into contact with sharp edges or moving parts. This will reduce the risk of accidental drops, which could cause injury and damage to the cable.
- Keep the cable and charger away from heat sources to prevent damage to the case or internal parts.
- Do not leave gasoline, oils, petroleum products, etc. come into contact with the plastic parts. They contain chemicals that can damage, weaken or destroy plastic
- Always wear safety glasses per ANSI Z87.1 during use.
- Use an extension cord only if absolutely necessary. Using an improper extension cord increases the risk of fire and electric shock. If it is necessary to use an extension cord, make sure that :
 - a) The plug of the extension cord is similar to the plug of the charger.
 - b) The extension cord has been properly connected to the outlet and is in good working order, showing no damage.
 - c) The cross-section of the wires is large enough for the rated power of the charger.
- Do not use the charger if it has been bumped, dropped or damaged in any way. Take it to an authorized RURIS service center for checking.
- Do not disassemble the charger. Take it to an authorized RURIS service center when it needs to be repaired.
- Unplug the charger from the outlet before maintenance, cleaning or any other operation to reduce the risk of electric shock.

- Unplug the charger from the power source when not in use. This will reduce the risk of electric shock or damage to the charger. It will also help prevent damage to the charger during a power surge.
- Risk of electric shock. Do not touch the uninsulated portion of the output connector or the uninsulated battery terminal.
- Keep these instructions. Refer to them frequently and use them to train others who may use the product.

6.1 ASSEMBLY

BEFORE CHARGING:

WARNING: Do not use this product if it is not fully assembled or if some parts are missing or damaged. Use of a product that is not properly and completely assembled, with damaged or missing parts, may result in serious personal injury.

WARNING: Do not attempt to modify the charger or battery, as this may result in possible personal injury.

6.2 OPERATION OF THE LOADER

WARNING: Always use caution when using the charger.

WARNING: Always wear safety glasses per ANSI Z87.1.

APPLICATIONS

You can use this product for the following purpose:

- Charging RURIS 40 volt lithium-ion batteries

CAUTION: If at any point during the charging process none of the LEDs are lit, remove the battery from the charger to avoid product damage. **DO NOT** insert another battery. Contact an authorized RURIS service.

NOTE: Charge in a well-ventilated area. Do not block the charger's vents. Keep them loose to allow for proper ventilation.

6.3 CHARGING THE BATTERY

Batteries are shipped in a low state of charge to prevent potential problems. Therefore, they must be charged before first use. If the battery does not charge when you connect it to the charger, contact an authorized RURIS service.

The charging time varies and depends on the Ah capacity of the battery.

NOTE: Do not use the charger in an area of extreme heat or cold. It will work best at normal room temperature. The battery will become slightly warm to the touch during charging. This is normal and does not indicate a problem.

1. Plug the charger into the household outlet, make sure the power source at the outlet is 220V, AC only, 50Hz.
2. Connect the battery to the charger by aligning the raised ribs on the battery with the grooves in the charger, then slide the battery onto the charger.
3. Press down on the battery to make sure it is properly connected to the charger. The green LED will flash as the battery is charging.
4. After charging is complete, the green LED will stay on.
5. To remove the battery from the charger, slide the battery back.

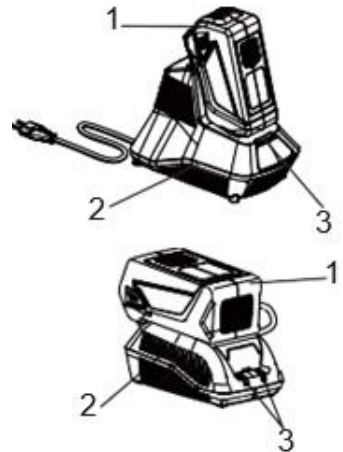

6.4 CHARGING A HOT BATTERY



When using a tool continuously, the battery can become hot. A hot battery should not be placed directly on the charger port until the battery temperature has dropped. When a hot battery is connected to the charger, the red LED will turn on and the green LED will turn off. Disconnect the battery from the charger, let it cool for 30 minutes.



6.5 CHARGING A COLD BATTERY



A cold battery can be placed directly on the charger port, but charging will not begin until the battery temperature is within the acceptable temperature range. When a cold battery



is connected to the charger, the red LED will turn on and the green LED will turn off. When the battery heats up, the charger will automatically start charging.

6.6 LED FUNCTIONS

Battery pack	RED LED	GREEN LED	ACTION
	 LED ROŞU	 LED VERDE	
With battery pack	Torn off	Flashing	The battery is charging

	 LED ROŞU	 LED VERDE	
With battery pack	Torn off	Constantly lit	Battery charged, remove battery

	 LED ROŞU	 LED VERDE	
With battery pack	Constantly lit	Torn off	Battery is too hot/cold. Remove for about 30 minutes to bring the temperature down to an acceptable temperature.

	 LED ROŞU	 LED VERDE	
With battery pack	Flashing	Flashing	The battery is defective, remove the battery



			immediately and contact a RURIS service.
--	--	--	---